



Series-53 Ball Sealing Plugs

Plug material: Stainless Steel

Ball material: Stainless Steel

Ball Sealing Plug

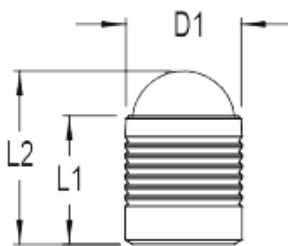

Bore to be sealed

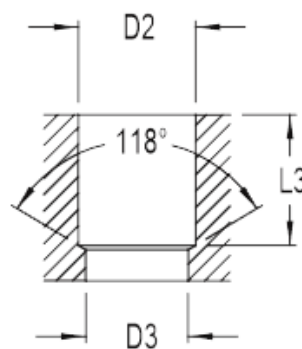

Ball Sealing Plug sealing the bore

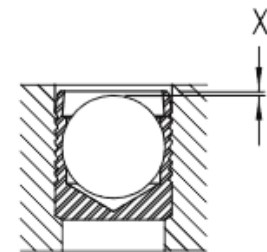

D1	L1	L2	D2 + 0.1	D3 max.	L3 min.	X +/- .2	Order Code
3.0	3.6	4.6	3.0	2.2	3.4	0.4	53-030
4.0	4.0	5.2	4.0	3.3	3.8	0.2	53-040
5.0	5.5	7.1	5.0	4.3	5.3	0.4	53-050
6.0	6.5	8.7	6.0	5.3	6.3	0.4	53-060
7.0	7.5	10.2	7.0	6.4	7.3	0.4	53-070
8.0	8.5	11.6	8.0	7.4	8.3	0.3	53-080
9.0	10.0	13.6	9.0	8.4	9.8	0.4	53-090
10.0	11.0	15.2	10.0	9.4	10.8	0.4	53-100
12.0	13.0	17.9	12.0	10.6	12.8	0.4	53-120
14.0	15.0	20.6	14.0	12.7	14.5	0.4	53-140

Dimensions in mm